



BH1A1500A **1,5T donkraft i aluminium**



PRODUKTOPLYSNINGER

- 1,5T donkraft i 100% aluminiumskonstruktion til vejservice eller motorsport
- Vejer kun 12,8 kg
- Lav indgangshøjde: 85 mm
- Stor løftehøjde: 415 mm
- Leveres i en transporttaske af nylon
- Går hurtig i indgreb takket være det dobbelte stempelsystem
- Udstyret med en praktisk værktøjsbakke
- Skum- og gummimanchetter på håndtaget forhindrer skade på karosseriet
- Aluminiumshjul
- CE-certificeret af Official Independent Technical Inspection Association

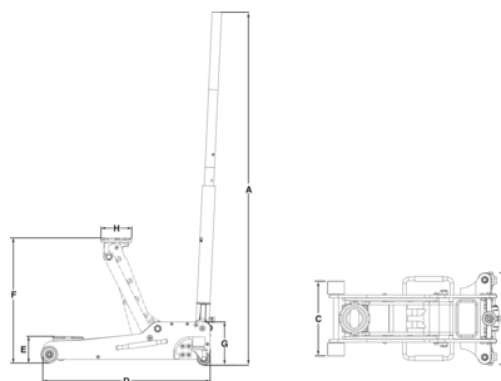









Follow the Fish!



PRODUKTATTRIBUTTER

Produkt: **BH1A1500A**

	1500 kg		85 mm		415 mm
	542 mm		5		97 mm
	-		Yes	A	1060 mm
B	250 mm	C	218 mm	D	542 mm
E	85 mm	F	415 mm	G	130 mm
H	97 mm		12.8 kg		

